

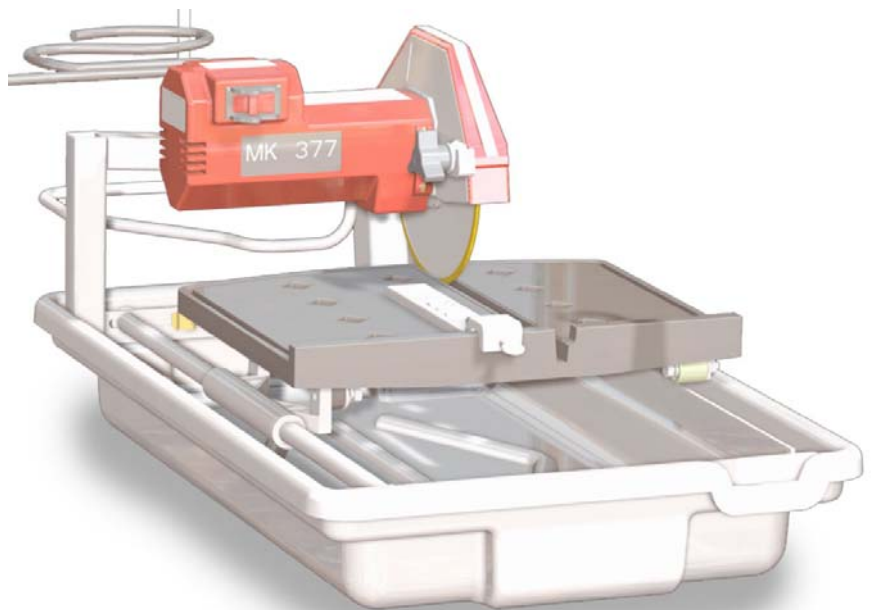

# MK-377 SERIES

**TILE SAW  
OWNER'S MANUAL &  
OPERATING INSTRUCTIONS**



**CAUTION:**  
Read all safety and  
operating instructions  
before using this  
equipment

Enter the Serial Number of your new saw in the  
space below. The Serial Number is located on the  
left side of the blade guard.

**SERIAL NUMBER:**

**NOTE:**

For your (1) one year warranty to be effective,  
complete the warranty card (including the Serial  
Number and mail it in as soon as possible.

## INTRODUCTION

We at MK Diamond want to congratulate you on selecting the MK-377 Tile Saw. We are certain that you will be pleased with your purchase. MK Diamond takes pride in producing the finest products in the industry.

Operated correctly, your MK-377 should provide you with years of quality service. In order to help you, we have included this manual. This owner's manual contains information necessary to operate and maintain your MK-377 safely and correctly. Please take a few minutes to familiarize yourself with the MK-377 by reading and reviewing this manual.

If you should have questions concerning your MK-377, please feel free to call our friendly customer service department at: 800 421-5830

Regards,

MK Diamond

# TABLE OF CONTENTS

	<b>Page</b>
<b>SAFETY:</b>	4
Safety Messages	4
Damage Prevention Message	4
General Safety Precautions and Hazard Symbols	4
California Proposition 65 Message	6
Electrical Requirements and Grounding Instructions	7
Tile Saw Specific Warnings	9
Product Specifications	9
<b>EXPLODED VIEW AND PARTS LIST</b>	
Exploded View	10
Parts List	11
<b>THEORY</b>	
Theory of Diamond Saws	13
<b>ACCESSORIES</b>	
Accessories	14
<b>ORDERING and RETURN INSTRUCTIONS</b>	
Ordering Information	15
Return Material Policy	15
Packaging Instructions	15
Authorized Service Centers	15

Manual Part No. 160030

Revision No. 03/03

## SAFETY

Read and follow all safety, operating and maintenance instructions. Failure to read and follow these instructions could result in injury or death to you or others. Failure to read and follow these instructions could also result in damage and/or reduced equipment life.

### **SAFETY MESSAGES:**

Safety messages inform the user about potential hazards that could lead to injury, death and/or equipment damage. Each safety message will be preceded by one of the following (3) three words that identify the severity of the message.

#### **▲ DANGER**

Not following instructions **WILL** lead to **DEATH** or **SERIOUS INJURY**

#### **▲ WARNING**

Not following instructions **COULD** lead to **DEATH** or **SERIOUS INJURY**

#### **▲ CAUTION**

Not following instructions **CAN** lead to injury

### **DAMAGE PREVENTION AND INFORMATION MESSAGES:**

A Damage Prevention Message is to inform the user of important information and/or instructions that could lead to equipment or other property damage if not followed. Information Messages convey information that pertains to the equipment being used. Each message will be preceded by the word NOTE, as in the example below.

#### NOTE:

Equipment and/or property damage may result if these instructions are not followed.

### **GENERAL SAFETY PRECAUTIONS AND HAZARD SYMBOLS:**

In order to prevent injury, the following safety precautions and symbols should be followed at all times!

#### **Safety Precautions:**

##### KEEP GUARDS IN PLACE.



In order to prevent injury, keep guards in place and in working order at all times.

##### REMOVE ADJUSTING KEYS AND WRENCHES.

Form a habit of checking to see that keys and adjusting wrenches are removed from the power tool before it is turned on.

##### KEEP WORK AREA CLEAN.

Cluttered work areas and benches invite accidents.

##### DO NOT USE IN DANGEROUS ENVIRONMENTS.

Do not use power tools in damp or wet locations nor expose them to rain. Always keep the work area well lighted.

##### KEEP CHILDREN AWAY.

All visitors and children should be kept a safe distance from work area.

##### MAKE THE WORKSHOP KID PROOF.

Make the workshops kid proof by using padlocks, master switches or by removing starter keys.

##### DO NOT FORCE THE TOOL.

A power tool will do a job better and safer operating at the rate for which it was designed.

##### USE THE RIGHT TOOL.

Do not force a tool or an attachment, to do a job that it was not designed to do.

## SAFETY

### USE THE PROPER EXTENSION CORD.

If using an extension cord make sure it is in good condition first. When using an extension cord, be sure to use one heavy enough to carry the current your product will draw. An undersized cord will cause a drop in line voltage that will result in a loss of power and overheating. TABLE 1, Page 8 shows the correct AWG size to use depending on cord length and nameplate ampere rating. If in doubt, use the next heavier gage. The smaller the gage number, the heavier the cord.

### WEAR PROPER APPAREL.

Do not wear loose clothing, gloves, neckties, rings, bracelets, or other jewelry that may be caught in moving parts. Non-slip footwear is recommended. Wear protective hair covering to contain long hair.

### ALWAYS USE SAFETY GLASSES.



Safety glasses should always be worn when working around power tools. In addition, a face, dust mask or respirator should be worn if a cutting operation is dusty. Everyday eyeglasses only have impact resistant lenses and may not prevent eye injury—they are NOT safety glasses.

### SECURE WORK.

Clamps or a vise should be used to hold work whenever practical. Keeping your hands free to operate a power tool is safer.

### DO NOT OVERREACH.

Keep proper footing and balance at all times by not overreaching.

### MAINTAIN TOOLS WITH CARE.

Keep tools clean for the best and safest performance. Always follow maintenance instructions for lubricating, and when changing accessories.

### DISCONNECT TOOLS.

Power tools should always be disconnected before servicing or when changing accessories, such as blades, bits, cutters, and the like.

### REDUCE THE RISK OF UNINTENTIONAL STARTING.



Make sure the ON/OFF switch is in the OFF position before plugging in a power tool.

### USE RECOMMENDED ACCESSORIES.

Consult the owner's manual for recommended accessories. Using improper accessories may increase the risk of personal or by-stander injury.

### NEVER STAND ON THE TOOL.

Serious injury could occur if a power tool is tipped, or if a cutting tool is unintentionally contacted.

### CHECK FOR DAMAGED PARTS.

Before using a power tool, check for damaged parts. A guard or any other part that is damaged should be carefully checked to determine it would operate properly and perform its intended function. Always check moving parts for proper alignment or binding. Check for broken parts and mountings and all other conditions that may affect the operation of the power tool. A guard, or any damaged part, should be properly repaired or replaced.

### DIRECTION OF FEED.

Always feed work into a blade or cutter against the direction of rotation. A blade or cutter should always be installed such that rotation is in the direction of the arrow imprinted on the side of the blade or cutter.

### NEVER LEAVE A TOOL RUNNING UNATTENDED – TURN POWER OFF.

Do not leave a tool until it comes to a complete stop. Always turn a power tool OFF when leaving the work area, or, when a cut is finished.

## SAFETY

### Hazard Symbols:

#### ELECTRICAL SHOCK!



Never touch electrical wires or components while the motor is running. Exposed, frayed or worn electrical motor wiring can be sources of electrical shock that could cause severe injury or burns.

#### ACCIDENTAL STARTS!



Before plugging the equipment into an electrical outlet, be sure the ON/OFF switch is in the OFF position to prevent accidental starting. Unplug the power tool before performing any service operation.

#### ROTATING OR MOVING PARTS!



Keep hands, feet, hair, and clothing away from all moving parts to prevent injury. Never operate a power tool with covers, shrouds, or guards removed.

#### **▲WARNING**

Sawing and drilling generates dust. Excessive airborne particles may cause irritation to eyes, skin and respiratory tract. To avoid breathing impairment, always employ dust controls and protection suitable to the material being sawed or drilled; See OSHA (29 CFR Part 1910.1200). Diamond Blades improperly used are dangerous. Comply with American National Standards Institute Safety Code, B7.1 and, Occupational Safety and Health Act covering Speed, Safety Guards, Flanges, Mounting Procedures, General Operating Rules, Handling, Storage and General Machine Conditions.

### **CALIFORNIA PROPOSITION 65 MESSAGE:**

#### **▲WARNING**

Some dust created by power sanding, sawing, grinding, drilling, and other construction activities contain chemicals known [to the State of California] to cause cancer, birth defects or other reproductive harm. Some examples of these chemicals are:

- Lead, from lead-based paints
- Crystalline silica, from bricks and cement and other masonry products and
- Arsenic and chromium, from chemically treated lumber

For further information, consult the following sources:

<http://www.osha-slc.gov/sltc/silicacrystalline/index.html>

[http://www.oehha.org/prop65/out\\_of\\_date/6022kLstA.html](http://www.oehha.org/prop65/out_of_date/6022kLstA.html)

Your risk from these exposures varies depending on how often you do this type of work. To reduce your exposure to these chemicals, work in a well-ventilated area, and work with approved safety equipment, such as those dust masks that are specially designed to filter out microscopic particles.

## SAFETY

### ELECTRICAL REQUIREMENTS AND GROUNDING INSTRUCTIONS:

In order to prevent potential electrical shock and injury, the following electrical safety precautions and symbols should be followed at all times!

#### ⚠ WARNING



In case of a malfunction or breakdown, grounding provides a path of least resistance for electric current to reduce the risk of electric shock. This tool is equipped with an electric cord having an equipment-grounding conductor and a grounding plug. The plug must be plugged into a matching outlet that is properly installed and grounded in accordance with all local codes and ordinances.

- Do not modify the plug provided – if it will not fit the outlet; have the proper outlet installed by a qualified electrician
- Improper connections of the equipment-grounding conductor can result in a risk of electric shock. The equipment-grounding conductor is the insulated conductor that has an outer surface that is green, with or without yellow stripes. If repair or replacement of the electric cord or plug is necessary, do not connect the equipment-grounding conductor to a live terminal
- Check with a qualified electrician or service personnel if the grounding instructions are not completely understood, or if in doubt as to whether the tool is properly grounded
- Use only 3-wire extension cords that have 3-prong grounding plugs and 3-pole receptacles that accept the tool's plug
- Repair or replace a damaged or worn cord immediately

#### ⚠ WARNING



This tool is intended for use on a circuit that has an outlet that looks like the one shown in Sketch A of Figure 1. The tool has a grounding plug that looks like the plug illustrated in Sketch A of FIGURE 1. A temporary adapter, which looks like the adapter illustrated in sketches B and C, may be used to

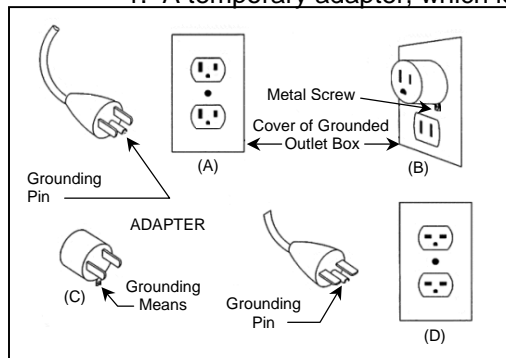

connect this plug to a 2-pole receptacle as shown in Sketch B, if a properly grounded outlet is not available. The temporary adapter should be used only until a properly grounded outlet can be installed by a qualified electrician. The green-colored rigid ear, lug, and the like, extending from the adapter, must be connected to a permanent ground such as a properly grounded outlet box.

NOTE: Use of a temporary adapter is not permitted in Canada.

FIGURE 1

#### ⚠ WARNING



To reduce the risk of electrocution, keep all connections dry and off the ground.

A Ground Fault Circuit Interrupter (GFCI) should be provided on the circuit(s) or outlet(s) to be used for the Tile Saw. Receptacles are available having built-in GFCI protections and may be used for this measure of safety.

When using an extension cord, the GFCI should be installed closest to the power source, followed by the extension cord and lastly, the saw.

# SAFETY

**⚠ WARNING**



To avoid the possibility of the appliance plug or receptacle getting wet, position the saw to one side of a wall mounted receptacle. This will prevent water from dripping onto the receptacle or plug. A "drip loop," shown in FIGURE 2, should be arranged by the user to properly position the power cord relative to the power source.

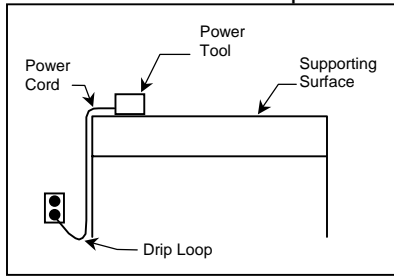

**FIGURE 2**

The "drip loop" is that part of the cord below the level of the receptacle, or the connector, if an extension cord is used. This method of positioning the cord prevents the travel of water along the power cord and coming in contact with the receptacle.

If the plug or receptacle gets wet, **DO NOT** unplug the cord. Disconnect the fuse or circuit breaker that supplies power to the tool. Then unplug and examine for presence of water in the receptacle.

**⚠ WARNING**



Use only extensions cords that are intended for outdoor use. These extension cords are identified by a marking "Acceptable for use with outdoor appliances; store indoors while not in use." Use only extension cords having an electrical rating not less than the rating of the product. Do not use damaged extension cords. Examine extension cords before using and replace if damaged. Do not abuse extension cords and do not yank on any cord to disconnect. Keep cords away from heat and sharp edges. Always disconnect the extension cord from the receptacle before disconnection the product from the extension cord.

To reduce the risk of electrocution, keep all connections dry and off the ground. Do not touch the plug with wet hands.

**⚠ WARNING**



Use of undersize extension cords result in low voltage to the motor that can result in motor burnout and premature failure. MK Diamond warns that equipment returned to us showing signs of being run in a low voltage condition, through the use of undersized extension cords will be repaired or replaced totally at the customers expense. There will be no warranty claim.

To choose the proper extension cord,

- Locate the length of extension cord needed in TABLE 1 below.
- Once the proper length is found, move down the column to obtain the correct AWG size required for that length of extension cord.

As an example, a fifty (50) foot extension cord would require an AWG size of 16.

Extension Cord Minimum Gage for Length				
Volts	Total Length of Cord in Feet			
120V	<b>25 ft.</b>	<b>50 ft.</b>	<b>100 ft</b>	<b>150 ft.</b>
	AWG	AWG	AWG	AWG
	14	12	Not Recommended	

**TABLE 1**



## SAFETY

### **TILE SAW SPECIFIC WARNINGS:**

#### **⚠WARNING**

Wear eye protection.

Use splash hood for every operation for which it can be used.

Disconnect saw before servicing, when changing cutting blades, and cleaning.

Use tool only with smooth edge cutting blades free of openings and grooves.

Replace damaged cutting blade before operating.

### **PRODUCT SPECIFICATIONS:**

The MK-377 is a versatile Tile Saw. Operated and used according to this manual, the MK-377 will provide years of dependable service.

#### General Description:

The MK-377 Tile Saw is engineered as a tabletop or stand mounted wet tile saw. The saw includes a powerful 115v direct drive AC motor. The saw is capable of cutting tile up to twelve (12) inches in length and one and three quarter (1-3/4) inches thick in one pass.

#### Motor Specifications:

Motor specifications for the MK-377 are listed in Table 2 below.

Voltage	115 v
Motor Amperage	5.0 A
Frequency	50/60 Hz
RPM	5500 rpm
Horse Power	1/3 hp
Weight	22 lbs.

Table 2

#### Blade Capacity:

The MK-377 uses a seven (7) inch (178 mm) diameter, wet cutting continuous rim, MK Diamond blade with a five-eighths (5/8) inch (15.875 mm) arbor.

#### Tile Types:

The MK-377 can cut a variety of tile types including Porcelain, Terracotta, Marble, Quarry and Slate, or almost any other non-ferrous material.

#### NOTE:

The MK-377 is not designed to cut plastic or ferrous (metals) material.

# EXPLODED VIEW AND PARTS LIST

## EXPLODED VIEW:

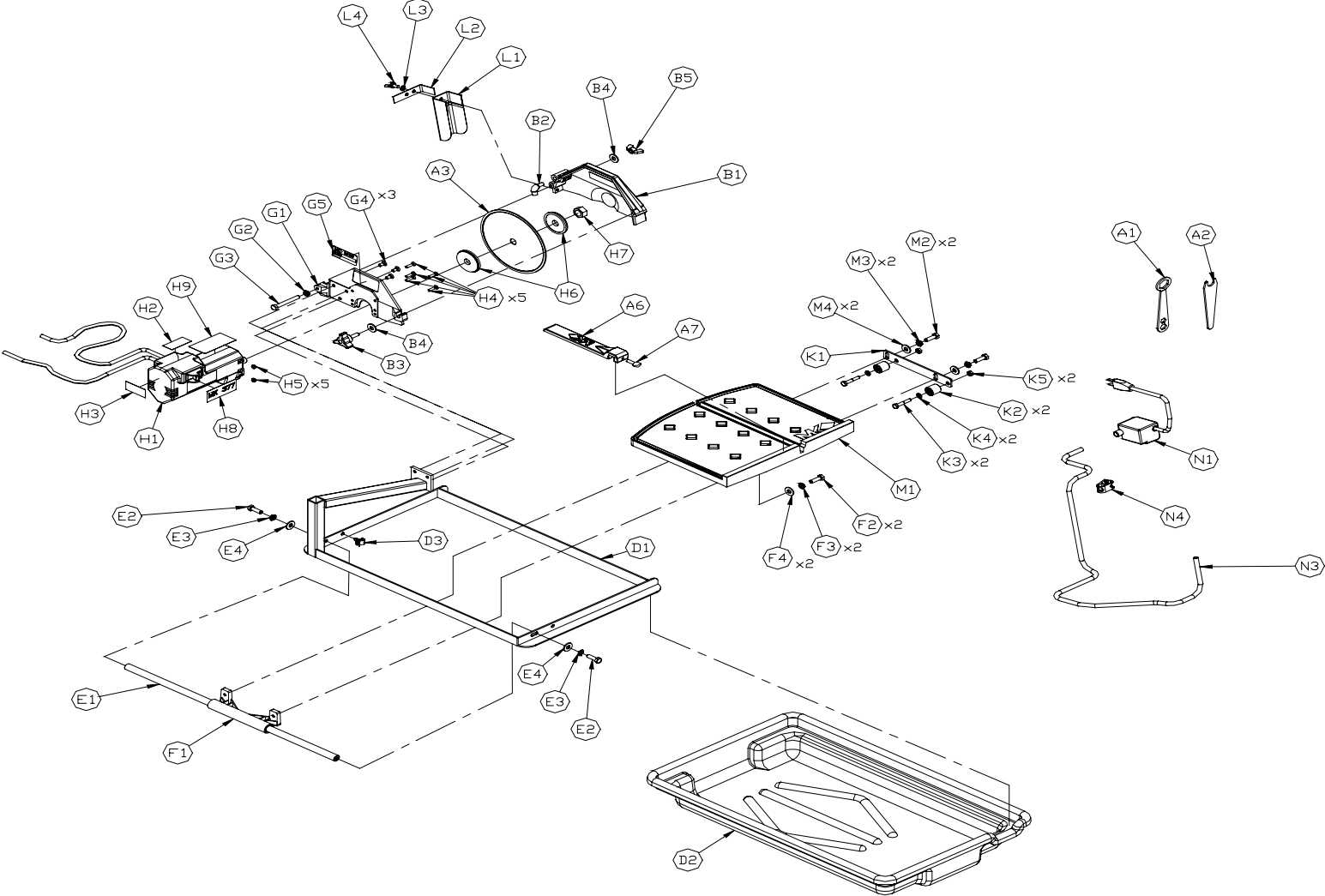

## EXPLODED VIEW AND PARTS LIST

### PARTS LIST:

Item	Description	Qty	Part #
<b>A</b>	<b>Accessories</b>	-	N/A
A1	Wrench, Blade Nut, 15/16 Boxed End	1	134684
A2	Wrench, Blade Shaft, 11/16 Open End	1	153450
A3	Blade, 7 Dia X 5/8 arbor MK-170	1	153441
A4*	Owner's Manual, 377	1	160030
A5*	Warranty Card	1	155037
A7	Assembly, Rip Guide w/ Screw, 1/4 -20 x 3/4 Thumb	1 1	134551 150991
<b>B</b>	<b>Assembly, Blade Guard, 7"</b>	1	154811-MK
B1	Guard, 7" Blade	1	154811
B2	Elbow, 1/8 MNPT X 1/4 BARB 90° Brass	1	154652
B3	Knob, Davies	1	151681
B4	Washer, 5/16 SAE Flat	2	151754
B5	Wing nut, 5/16-18 Nylock	1	151746
D1	Frame	1	155792
D2	Pan, Water	1	155791
D3	Cord Clip, 1/4 Push Mount	1	157259
<b>E</b>	<b>Assembly, 5/8 Guide Bar</b>	1	151739-MK
E1	Bar, Guide, 5/8 Dia	1	151739
E2	Screw, 5/16-18 X 1 Hex Head Cap	2	151743
E3	Washer, 5/16 Split Lock	2	151747
E4	Washer, 5/16 SAE Flat	2	151754
<b>F</b>	<b>Assembly, Linear Bearing, 5/8 Dia</b>	-	N/A
F1	Bearing, Linear, 5/8 Dia F1A Bearing, Multi-lube	1 2	157126 151781
F2	Screw, 5/16-18 X 1 Hex Head Cap	2	151743
F3	Washer, 5/16 Split Lock	2	151747
F4	Washer, 5/16 SAE Flat	2	151754
<b>G</b>	<b>Assembly, Motor Mount</b>	1	155811-MK
G1	Motor Mount	1	157403
G2	Washer, 5/16 Split Lock	1	151747
G3	Screw, 5/16-18 X 2 1/2 Hex Head Cap, Full Thread	1	151748
G4	Screw, 1/4-20 X 1/2 Flat Head Phillips Cap	3	155812
G5	Tag, Serial Number, No Mark	1	157249-01
H1	Motor, 120v/4.7a,	1	157226
H2	Label, Caution, GFCI, 1 X 2 1/8	1	155678
H3	Label, Caution, Receptacle, 1 X 2 1/8	1	154822
H4	Screw, M5-.8 X 20mm Flat Head Phillips Machine	5	157404
H5	Nut, M5-.8 Hex	5	157405
H6	Flange, Blade	2	135830
H7	Nut, 5/8-18 UNF	1	135848
H8	Label, 377 Model	1	160031
H9	Label, Warning, Read Owner's Manual	1	155806

## EXPLODED VIEW AND PARTS LIST

<b>K</b>	<b>Assembly, Roller Wheel, Double</b>	1	156586
K1	Bracket, Roller Wheel	1	156522
K2	Wheel, Roller	2	151799
K3	Screw, 1/4-20 X 1 1/2 Hex Head Cap	2	151914
K4	Washer, 1/4 SAE Flat	2	151915
K5	Nut, 1/4-20 Hex	2	151893
<b>L</b>	<b>Assembly, Splash Curtain</b>	1	155901-MK
L1	Curtain, Splash	1	134841
L2	Bracket, Splash Curtain	1	155901
L3	Washer, 1/4 SAE Flat	1	151915
L4	Wing screw, 1/4-20 X 1/2	1	151888
M1	Table, Composite, 370/470	1	156536
M2	Screw, 5/16-18 X 1 Hex Head Cap	2	151743
M3	Washer, 5/16 Split Lock	2	151747
M4	Washer, 5/16 SAE Flat	2	151754
<b>N</b>	<b>Assembly, PES-100 120v Water Pump</b>	1	155987-MK
N1	Pump, Water, PES-100 120v	1	155987
N2	Hose, Vinyl, 1/4 ID	2'	132951
N3	Clamp, Flow, 1/4-1/2	1	154394

## THEORY

### THEORY OF DIAMOND BLADES:

Diamond blades do not really cut; they grind the material through friction. Diamond crystals, often visible at the leading edge and sides of the rim/segment, remove material by scratching out particles of hard, dense materials, or by knocking out larger particles of loosely bonded abrasive material. This process eventually cracks or fractures the diamond particle, breaking it down into smaller pieces. As a result, a diamond blade for cutting soft, abrasive material must have a hard metal matrix composition to resist this erosion long enough for the exposed diamonds to be properly utilized. Conversely, a blade for cutting a hard, non-abrasive material must have a soft bond to ensure that it will erode and expose the diamonds embedded in the matrix. These simple principles are the foundation of “controlled bond erosion”.



#### Types of Cutting:

There are two basic types of cutting-Dry or Wet. The choice of which type of blade to use depends on:

- The requirements of the job
- The machine/tool utilizing the diamond blade
- The preference of the operator







In the case of DRY cutting, the overwhelming popularity and quantity of hand-held saws and the flexible nature of MK Diamond blades to professionally handle most ceramic, masonry, stone and concrete materials, make the DRY cutting blade a very attractive tool. When using a DRY blade, the user must be aware of distinct operating practices to ensure optimum performance. DRY cutting blades require sufficient airflow about the blade to prevent overheating of the steel core. This is best accomplished by shallow, intermittent cuts of the material with periods of “free-spinning” (for several seconds) between each cut, to maximize the cooling process.

For WET cutting applications, MK has the exact blade to compliment both the material to be cut and the wet cutting machine to be used. During cutting operations, liberal amounts of water act as a coolant to support the cutting effectiveness and longevity of the WET blade. Additionally, using water adds to the overall safety of cutting operations by keeping the dust signature down.

Know All You Can About the Material You Wish to Cut

## ACCESSORIES

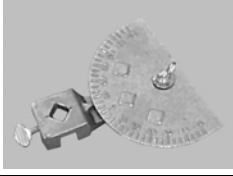
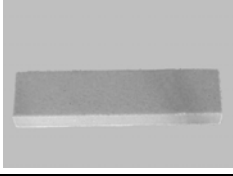
### ACCESSORIES:

ITEM	NUMBER	DESCRIPTION	
1.	139295	MK-200, 7 x 5/8 Arbor	
2.	139311	MK-215, 7 x 5/8 Arbor	
3.	153293	MK-315, 7 x 5/8 Arbor	
4.	134569-MK	Dual 45° Flat Angle Guide	
5.	134585-MK	45° Bullnose Miter	
6.	134569-MK	90° Protractor	
7.	152792	Dressing Stone	
8.	152610	Ground Fault Circuit Interrupter	
9.	155953	Stand	

## **ORDERING and RETURN INFORMATION**

### **ORDERING INFORMATION:**

You may order MK Diamond products through your local MK Diamond distributor or, you may order direct from MK Diamond.

NOTE: There is a \$25.00 minimum order when ordering direct from MK Diamond. All purchases must be made using VISA or MasterCard.

When ordering direct from MK Diamond, please have the following information ready before calling:

- The Model Number of the saw
- The Serial Number of the saw
- Where the saw was purchased and when
- The Part Number for the part(s) being ordered
- The Part Description for the part(s) being ordered

All parts may be ordered by calling toll free to – **800 421-5830** or **310 539-5221** and asking for Customer Service. For technical questions, call – **800 474-5594**.

### **RETURN MATERIALS POLICY:**

To expedite the service relative to the return of a product purchased through MK Diamond, please observe the following:

NOTE: When returning all items, they must have been purchased within the previous twelve (12) months.

- Have the Model Number of the saw
- Have the Serial Number of the saw
- Have the location of where the saw was purchased
- Have the date when the saw was purchased
- Contact Customer Service for approval to return the item(s)
- Obtain a Returned Goods Number (RGA) authorizing the return
- Follow the packaging instructions in the following section
- Ensure your item(s) are prepaid to the destination

For returned items, call toll free to – **800 421-5830** or **310 539-5221** and ask for Customer Service. For technical questions, call – **800 474-5594** or **310 257-2845**.

### **PACKAGING INSTRUCTIONS:**

- Remove the Blade guard and Support Angle Assembly
- Dry the saw before shipping
- When packing, include the following: MK-377, Diamond Blade, Blade guard and Support Angle Assembly and Adjustable Cutting Guide (Other Accessories are not required)
- Package the unit in its original container or one of comparable size (do not ship the unit partially exposed)
- Ensure all parts are secured in the packaging to prevent moving

### **AUTHORIZED SERVICE CENTERS:**

For quicker repair time, you may contact MK Diamond Customer Service, toll free, at – **800 421-5830** or **310 539-5221** for the Authorized Service Center closest to you. For technical questions, call – **800 474-5594**.

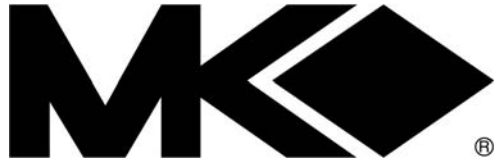

# MK-377 SERIES

## TILE SAW OWNER'S MANUAL & OPERATING INSTRUCTIONS

### **CALIFORNIA PROPOSITION 65 MESSAGE:**

#### **⚠️WARNING**

Some dust created by power sanding, sawing, grinding, drilling, and other construction activities contain chemicals known [to the State of California] to cause cancer, birth defects or other reproductive harm. Some examples of these chemicals are:

- Lead, from lead-based paints
- Crystalline silica, from bricks and cement and other masonry products and
- Arsenic and chromium, from chemically treated lumber

Your risk from these exposures varies depending on how often you do this type of work. To reduce your exposure to these chemicals, work in a well-ventilated area, and work with approved safety equipment, such as those dust masks that are specially designed to filter out microscopic particles.

**MK DIAMOND PRODUCTS, INC**  
**1315 STORM PARKWAY, TORRANCE, CA 90509-2803**  
**310 539 5158**